

Valid for Item-No.: 3043000/3043100/3043200/3043010/3043110/3043210/3043080/3043002/3043102/3043012/3043112

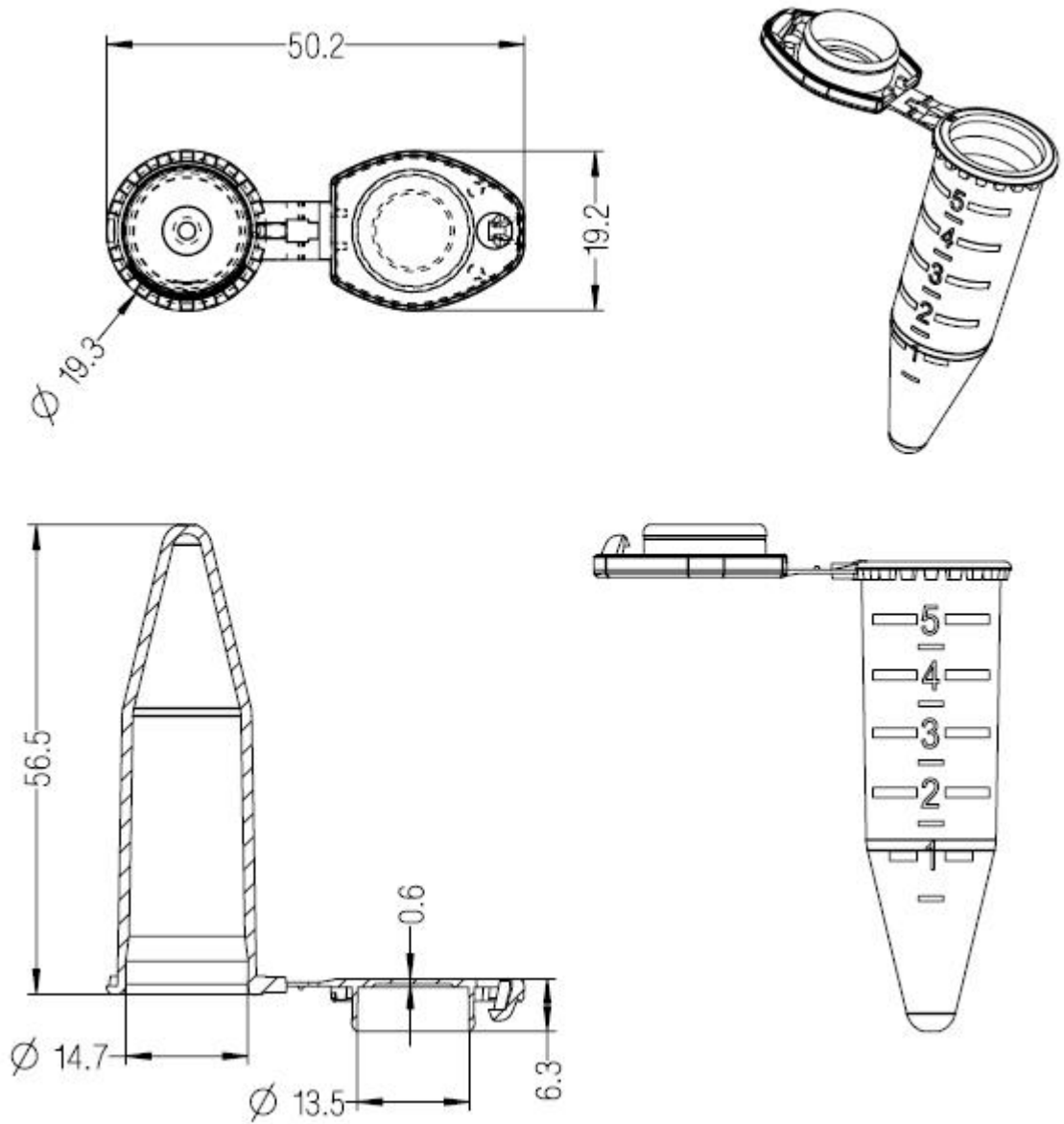

"All dimensions in mm"

Customer drawing subject to change without notice!

Uncontrolled Copy

Prior Issue	Drawn	Approved	Released	CONFIDENTIAL: Information contained in this document or drawing is confidential and proprietary to Saining Biotechnology Co., Ltd. This document may not be reproduced for any reason without written permission from Saining Biotechnology Co., Ltd. All rights of design, invention, and copyright are reserved.
Revision 1	Date 2024/05/07	Date 2024/05/07	Date 2024/05/07	
Date 2024/05/07	Name	Name	Name	